

DRAN I 20 SERIES

AC - DC DIN RAIL MOUNTABLE POWER SUPPLY
INDUSTRIAL CONTROL EQUIPMENT



FEATURES

- PFC FUNCTION AVAILABLE
- PARALLEL FUNCTION AVAILABLE (SWITCH)
- INPUT VOLTAGE 115/230VAC AUTO SELECT
- SELV COMPONENTS DESIGN
- 3 YEARS WARRANTY



SELECTION CHART

DRAN I 20 - 24 x

Wattage

12 : 12V OUT
24 : 24V OUT
48 : 48V OUT

A : SCREW TERMINAL TYPE
B : DETACHABLE CONNECTOR TYPE
AL / BL : CLASS 2 POWER (24V ONLY)

MODEL LIST

MODEL NO.	INPUT VOLTAGE	OUTPUT WATTAGE	OUTPUT VOLTAGE	OUTPUT CURRENT	EFF. (min.)	EFF. (typ.)
Single Output Models						
DRAN I 20-12x	115 / 230 VAC	120 WATTS	+ 12 VDC	10A	82%	84%
DRAN I 20-24x	115 / 230 VAC	120 WATTS	+ 24 VDC	5A	84%	86%
DRAN I 20-24xL	115 / 230 VAC	91 WATTS	+ 24 VDC	3.8A	83%	85%
DRAN I 20-48x	115 / 230 VAC	120 WATTS	+ 48 VDC	2.5A	85%	87%

SPECIFICATION

All Specifications Typical At Nominal Line, Full Load, 25°C Unless Otherwise Noticed

GENERAL						
Characteristics	Conditions	min.	typ.	max.	unit	
Switching frequency	Vi nom, Io nom		55		KHz	
Isolation voltage	Input-Output	3,000 / 4,242			VAC / VDC	
	Input-FG	1,500 / 2,121			VAC / VDC	
	Output-FG	500 / 710			VAC / VDC	
Isolation resistance	Input-Output, @ 500VDC	100			MΩ	
Ambient temperature	Operating at Vi nom	-35		+ 71	°C	
Derating (see derating curve)	Vi nom, from +61 to +71°C			2.5	% / °C	
Storage temperature	Non operational	-40		+ 85	°C	
Relative humidity	Vi nom, Io nom	20		95	% RH	
Temperature coefficient	Vi nom, Io min			± 0.03	% / °C	
MTBF	Bellcore Issue 6 @40°C, GB	12V	509,000		Hours	
		24V	530,000		Hours	
		AL / BL	659,000		Hours	
		48V	600,000		Hours	
Altitude during operation	EN 60950-1			5,000	m	
Dimension	Screw terminal type	L124.5 x W64 x D123.6			mm	
	Detachable connector type	L143.5 x W64 x D123.6			mm	
Cooling	Free air convection					
Installation position	Vertical (other direction may derating using)					
Pollution degree		2				



SPECIFICATION

All Specifications Typical At Nominal Line, Full Load, 25°C Unless Otherwise Noticed

INPUT SPECIFICATIONS

Characteristics	Conditions		min.	typ.	max.	unit
Rated input voltage	Io nom		115 / 230 (auto select)			VAC
Absolute input max. range	Ta min ... Ta max, Io nom	AC in 115V selected	90		132	VAC
		AC in 230V selected	180		264	VAC
		DC in	210		375	VDC
Input current	Vi : 115 / 230 VAC, Io nom			2.2 / 0.83		A
	AL, BL models			1.65 / 0.65		A
Rated input current	Vi : 90 / 180 VAC, Io nom				2.8 / 1.4	A
	AL, BL models				2.0 / 0.8	A
Line frequency	Vi nom, Io nom		47		63	Hz
Inrush current	Vi : 115 / 230 VAC, Io nom				24 / 48	A
Power dissipation	Vi : 230 VAC, Io nom	12V		24		W
		24V		20		W
		AL / BL		16		W
		48V		19		W
Leakage current	Input-Output				0.25	mA
	Input-FG				3.5	mA
Power factor (Passive)	Vi : 230VAC, Io nom			0.7		

OUTPUT SPECIFICATIONS

Characteristics	Conditions		min.	typ.	max.	unit
Output voltage accuracy (Adjusted before shipment)	Vi nom, Io max		0		+ 1	%
Minimum load	Vi nom		0			%
Line regulation	Io nom, Vi min ... Vi max				± 0.5	%
Load regulation	Vi nom, Io min ... Io nom	single mode			± 1	%
		parallel mode			± 5	%
Voltage trim range	Vi nom, 0.8 Io nom	12V	11.4		14.5	VDC
		24V	22.5		28.5	VDC
		AL / BL	22.5		24.5	VDC
		48V	45		55	VDC
Rated continuous loading	Vi nom	12V	10 A @ 12Vdc / 8.2 A @ 14.5 Vdc			
		24V	5 A @ 24Vdc / 4.2 A @ 28.5 Vdc			
		AL / BL	3.8 A @ 24Vdc / 3.7 A @ 24.5 Vdc			
		48V	2.5 A @ 48Vdc / 2.1 A @ 55 Vdc			
Hold up time	Vi : 115 / 230 VAC, Io nom		25 / 30			ms
Turn on time	Vi nom, Io nom				1,000	ms
	Vi nom, Io nom → 12V model : with 7000 μF CAP 24V, 48V models : with 3500 μF CAP				1,500	ms
Rise time	Vi nom, Io nom				150	ms
	Vi nom, Io nom → 12V model : with 7000 μF CAP 24V, 48V models : with 3500 μF CAP				500	ms
Fall time	Vi nom, Io nom				150	ms
Transient recovery time	Vi nom, I ~ 0.5 Io nom				2	ms
Ripple & noise	Vi nom, Io nom, BW = 20MHz				50	mV
Power back immunity	Vi nom, Io nom	12V	18			VDC
		24V	35			VDC
		48V	63			VDC
Capacitor load	Vi nom, Io nom	12V			7,000	μF
		24V, 48V			3,500	μF
DC ON indicator threshold at start up (Green LED)	Vi nom, Io nom	12V	10		11.2	VDC
		24V	17.6		19.4	VDC
		48V	37		43	VDC
DC LOW indicator threshold after start up (Red LED)	Vi nom, Io nom	12V	10		11.2	VDC
		24V	17.6		19.4	VDC
		48V	37		43	VDC
Parallel operation	0.1 Io min ~ 0.9 Io max (Except AL / BL models)				3	unit
Efficiency	Vi nom, Io nom, Po / Pi		Up to 87%, See model list and typ efficiency curve			

SPECIFICATION

All Specifications Typical At Nominal Line, Full Load, 25°C Unless Otherwise Noticed

CONTROL AND PROTECTION

Characteristics	Conditions	min.	typ.	max.	unit
Input fuse		T3.15A / 250VAC internal			
Internal surge voltage protection	IEC 61000-4-5	Varistor			
Rated over load protection	Vi nom (see typ current limited curve)	110		145	%
	AL / BL	102		108	%
Power Rdy (for 24V model only)	Threshold voltage of contact closed (at start up)	17.6		19.4	VDC
	Electrical isolation	500			VDC
	Contact rating at 60VDC			0.3	A
Over voltage protection	Vi nom, 0.8 Io nom (Auto Recovery)	12V	15	16.8	V
		24V	30	33	V
		48V	60	66	V
		AL / BL	24.5	25.5	V
Output short circuit		Fold forward			
Degree of protection		IP20			

APPROVALS AND STANDARDS

UL / cUL	UL 508 Listed UL 60950-1, UL 1310 Class 2 Power (24AL/BL models only) Recognized ISA 12.12.01(Class I, Division 2, Groups A, B, C and D)
TUV	EN 60950-1 EN 61558-1, EN 61558-2-16 (meet EN 60204-1)
CE	EN 61000-6-3, EN 55032 Class B, EN 61000-3-2 Class D, EN 61000-3-3 EN 61000-6-2, EN 55024, EN 61000-4-2 Level 4, EN 61000-4-3 Level 3 EN 61000-4-4 Level 4, EN 61000-4-5 L-N Level 3, L / N-FG Level 4 EN 61000-4-6 Level 3, EN 61000-4-8 Level 4, EN 61000-4-11 ENV 50204 Level 2, EN 61204-3
CCC	GB4943.1, GB9254, GB17625.1
Vibration resistance	meet IEC 60068-2-6 (Mounting on rail : 10-500 Hz, 2G, along X, Y, Z each Axis, 60 min for each Axis)
Shock resistance	meet IEC 60068-2-27 (15G, 11ms, 3 Axis, 6 Faces, 3 times for each Face)

PHYSICAL CHARACTERISTICS

Case size	Screw terminal type	124.5 x 64 x 123.6 mm (4.9 x 2.52 x 4.87 inches)
	Detachable connector type	143.5 x 64 x 123.6 mm (5.65 x 2.52 x 4.87 inches)
Case material	Metal	
Weight	920g	
Packing	1.02kg ; 20pcs / 21.5kg / 2.01CUFT	

MECHANISM & PIN CONFIGURATION

mm [inch]

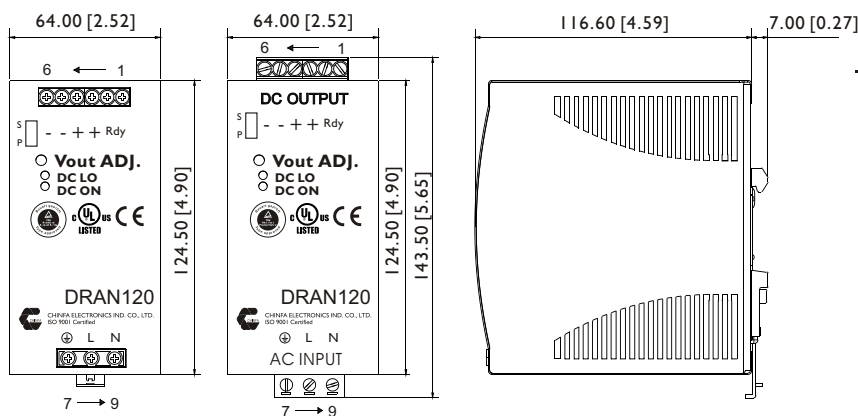

CONSTRUCTION

Easy snap-on mounting onto the DIN-Rail (TS35/7.5 or TS35/15), unit sits safely and firmly on the rail.

INSTALLATION

Ventilation / Cooling
Normal convection
All sides 25mm free space
For cooling recommended

Connector size range
Screw terminal:
AWG24-10 (0.2~4mm²) flexible / solid cable,
-Input connector can withstand torque at maximum 9 pound-inches.
-Output connector can withstand torque at maximum 5.5 pound-inches.
8 m/m stripping at cable end recommends

Detachable connector:
AWG24-12 (0.2~2.5mm²) flexible / solid cable,
-Input connector can withstand torque at maximum 4.5 pound-inches.
-Output connector can withstand torque at maximum 7 pound-inches.
4~5 m/m stripping at cable end recommends
Use copper conductors only, 60 / 75°C

GENERAL TOLERANCE

0.00[0.00] - 30.00[1.18]	±0.30[0.01]
30.00[1.18] - 120.00[4.72]	±0.50[0.02]
120.00[4.72] - 400.00[15.75]	±0.80[0.03]

PIN ASSIGNMENT

PIN NO.	Designation	Description
1	OUT	RDY
2		A normal open relay contact for DC ON level control (Never connect except 24V model)
3, 4		V +
5, 6		V -
7	IN	⊕
8		L
9		N
	OTHER	DC ON
		DC LO
		Vout ADJ.
		S / P

CIRCUIT SCHEMATIC

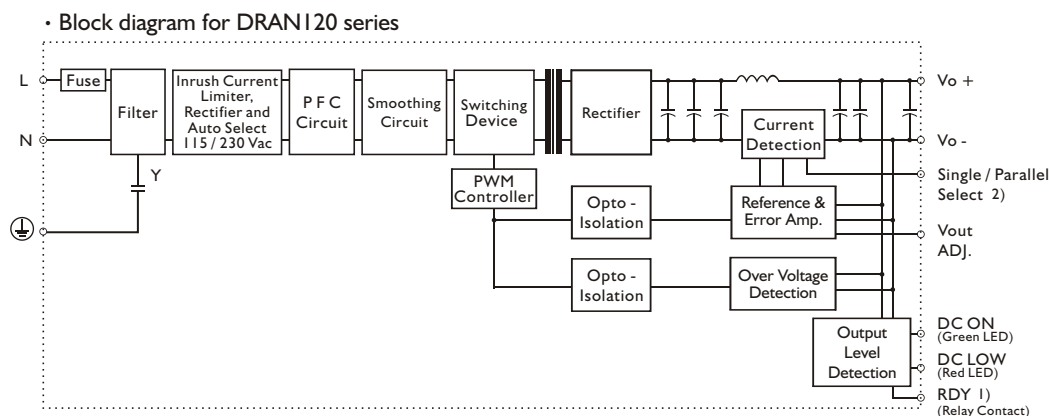

TYP. CURRENT LIMITED CURVE

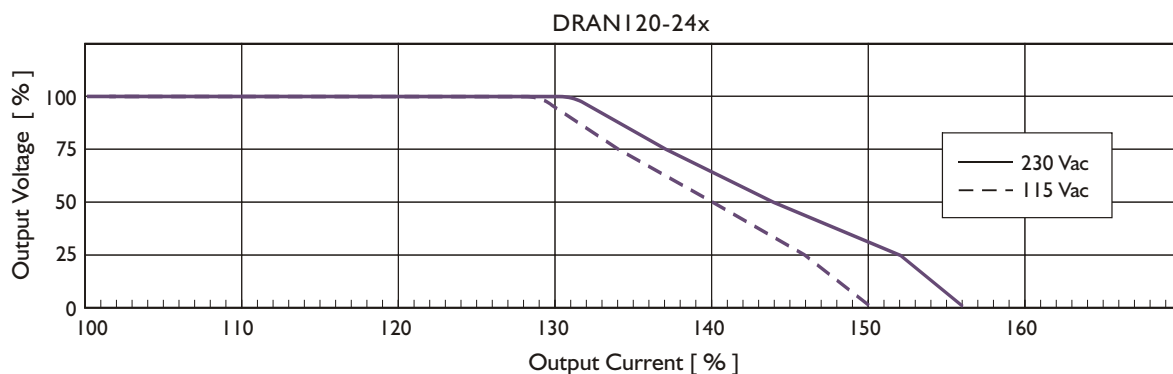

DERATING CURVE

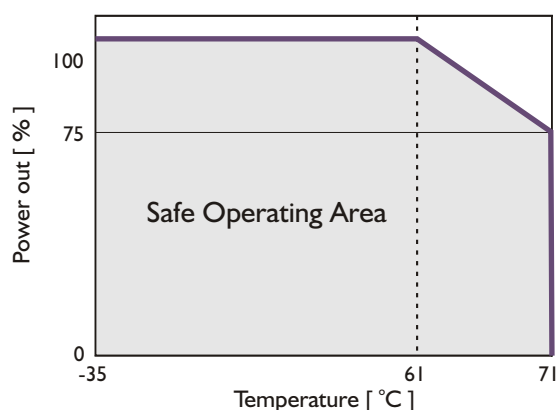

TYP. EFFICIENCY CURVE

